

U P S

On-Line

6KVA-10KVA

■ USER MANUAL ■

EMC Statement

These products are tested and thereby comply with the conditions of CE regulation, which established to offer sufficient protection against dangerous interference for installation. Installation and use of the equipment should comply with the instructions provided to avoid such interference due to the amount of radiofrequency energy that generates by the equipment; Despite this, we cannot assure that a certain amount of interference may not occur in some installations.

If by turning on and off, you conclude that the equipment's harmful interference influences your radio or television reception, use one of the following preventive measures:

- Place the receiving antenna in a separate location or orientation
- Ensure a greater distance between the receiver and the equipment
- Ensure that your Equipment connects to an outlet on a separate circuit
- Contact a technician experienced with radio and TV or the dealer for technical assistance

Declaration of Conformity Request

Units labelled with a CE mark comply with the following stander and directives:

- EMC Directive 2014/30/EU
- LVD Directive 2014/35/EU
- Safety: EN 62040 - 1
- EMC: EN 62040 - 2

The EC Declaration of Conformity is available upon request for production with a CE mark.

Table of content

EMC Statement.....	1
1. IMPORTANT SAFETY INSTRUCTION	3
2. Introduction	4
3. Installation	4
3.1 Hardware Installation.....	4
3.2 Rear panel view.....	5
3.3 Connection to External Battery Pack.....	6
3.4 Connection to Main and Load	7
4. Operation.....	9
4.1 General Description	9
4.2 System Configuration	10
4.3 Panel overview	10
4.4 UPS Control	11
4.5 UPS Status Display.....	12
4.6 UPS Configuration	13
5. UPS Monitoring Connection	14
5.1 Connect UPS to Computer with USB (Optional)/RS232 port.....	14
5.2 Connect UPS with interface Slot(Optional)	14
5.3 UPS RS232 PORT	14
6. Maintenance	15
6.1 Transportation	15
6.2 Storage	15
6.3 Operation	15
6.4 Battery.....	15
6.4.1 Maintenance	15
6.4.2 Replacement	15
6.4.3 External battery pack	16
APP-A. Troubleshooting.....	16
APP-B Technical Specifications	18

1. IMPORTANT SAFETY INSTRUCTIONS

WARNING: SAVE THESE INSTRUCTIONS!!

- **WARNING: Manual contains important instructions of UPS and batteries during installation and maintenance. Follow this instruction at all time**
 - **WARNING:** It is recommended to install UPS in an ANSI/NFPA75 room in which temperature and humidity are controlled and free from electrically conductive particles. **DO NOT** expose UPS to direct sunlight or high heat source; **DO NOT** block off ventilation opening around the housing.
 - **CAUTION:** Before conducting maintenance, repair, or shipment, please turn off everything completely and disconnect them.
 - **CAUTION:** The UPS is **NOT** applicable for any inductive loads such as motors or domestic appliances like hairdryers, speakers, and fluorescent lamps.
 - **CAUTION:** All interconnection and power cable should be connected **ONLY AFTER** the UPS shut down and disconnected from main.
 - **CAUTION:** Only use No.26 AWG or larger certified cables to connect UPS and device
 - **CAUTION:DO NOT** unplug UPS from main power during operation or protective ground will fail. **DO NOT** disconnect battery under load or shut down may occur.
 - **CAUTION:** Ensure the total leakage current of UPS and the connected equipment under 3.5mA.
 - **CAUTION:** Ensure UPS connects to grounded main power with a fuse or circuit breaker protection.
 - **CAUTION:** Dangerous amount of voltage might still exist even the UPS disconnects from the main power since residual voltage exists due to battery supply.
 - **CAUTION:** Beware of all the details on the cautionary sticker located on UPS.
 - **CAUTION (No user-serviceable parts):** Do not attempt to remove the unit's cover, no user-serviceable parts inside. Please refer all service to qualified service technicians.
 - **CAUTION:DO NOT** dispose UPS and its batteries to fire, the battery may explode
 - **CAUTION:DO NOT** attempt to open or mutilate the battery.
 - **User's operations:** Users only permits to:
 - Turning the UPS unit on and off.
 - Operating the user interface.
 - Connecting data interface cables.
 - Changing the batteries
 - **CAUTION:** Battery can cause shock and short circuit current. When servicing batteries:
 - A. Remove watches, rings, or other metal objects.
 - B. Use tools with insulated handles.
 - C. Wear rubber gloves and boots.
 - D. Please **DO NOT** place any tools or metal parts on top of batteries.
 - E. Disconnect charging source before connecting/disconnecting battery terminals
 - F. Servicing of batteries should be performed or supervised by personnel with necessary precautions and knowledge. Keep unauthorized personnel away from batteries.
 - **DANGER:** Hazardous electric component inside this unit (example: Heat-sinks) remain energized from the battery supply even when the main power is disconnected.
 - **DANGER:** Battery circuit is not isolated from the AC input. Hazardous voltage may exist at battery terminals and ground—test for safety before any direct contact.
 - **CAUTION:** Remove the battery's pole during service inside the battery cabinet or UPS.
 - **CAUTION:ONLY** replace batteries with the same type and quantity
- WARNING (Fuses):** Ensure fuse replacement with the same type and rating **ONLY**.
- WARNING :** This is a product for commercial and industrial application in the second environment installation restrictions or additional measures may be needed to prevent disturbances.

2. Introduction

The information provided in this manual covers On-Line 6K-10Kuninterruptible power system (UPS). This manual contains basic functions, operating procedures, and emergencies, also including information on how to ship, store, handle, and install the equipment. Only detailed requirements of the UPS units described herein. The installation must carry out according to this manual. The electrical installation must further comply with local legislation and regulations.

3. Installation

3.1 Hardware Installation

Rack Tower Stand Installation

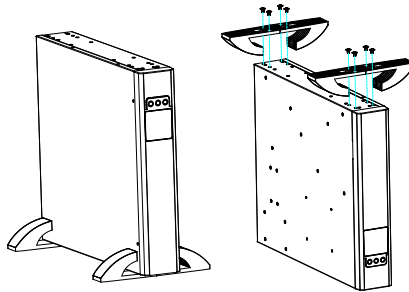

Here is the simple demonstration of UPS installing with rack stand. Attach rack tower stands to UPS, and use a screw to lock the stand in place

Rack mounting ear installation.

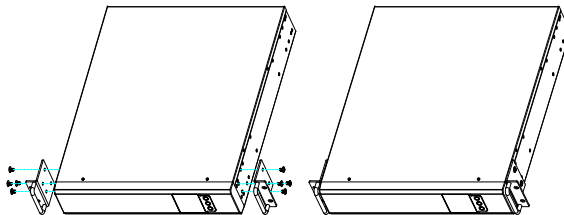

Here is one of the few examples to attach the mounting ear. Simply attach the ear to the matching side of UPS and use the screw to lock the ear for further application.

3.2 Rear panel view (For reference only)

6-10KVA

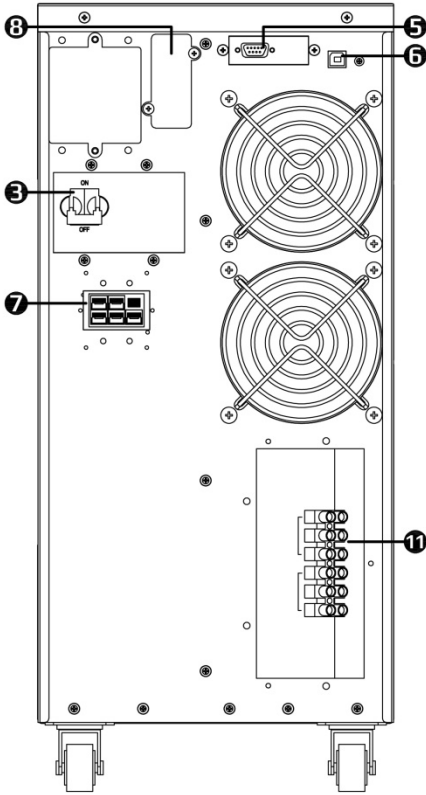

6KVA

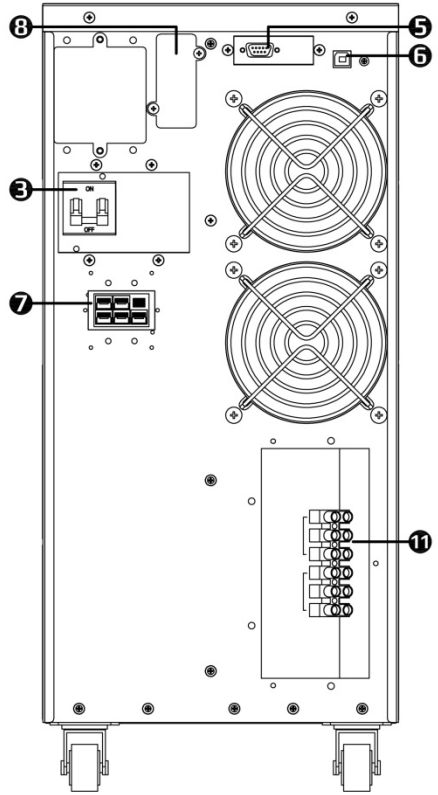

10KVA

- ① Input
- ② Outlet
- ③ Input breaker
- ④ Network transient protector
- ⑤ RS232 port
- ⑥ USB
- ⑦ External battery port (optional)

- ⑧ Interface port (optional)
- ⑨ EPO (optional)
- ⑩ Maintenance switch (optional)
- ⑪ Terminal block
- ⑫ Reset
- ⑬ Outlet breaker

6-10KVA

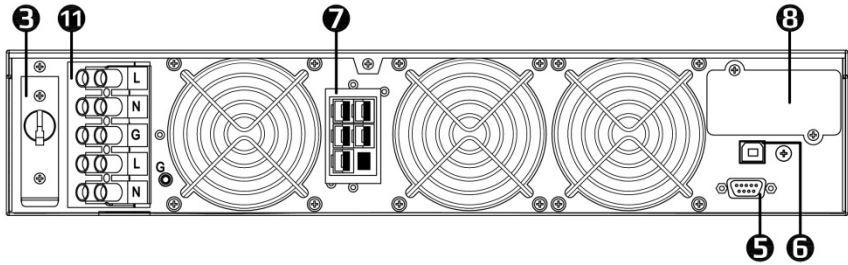

6KVA

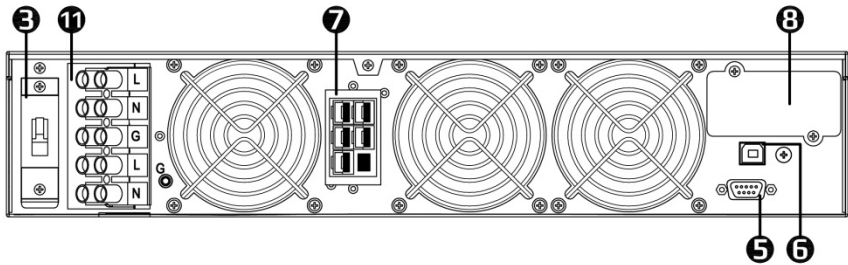

10KVA

- | | |
|-------------------------------|----------------------------------|
| 1 Input | 8 Interface port (optional) |
| 2 Outlet | 9 EPO (optional) |
| 3 Input breaker | 10 Maintenance switch (optional) |
| 4 Network transient protector | 11 Terminal block |
| 5 RS232 port | 12 Reset |
| 6 USB | 13 Outlet breaker |
| 7 External battery port | |

***Figures only display available function; functions are not on unit if not marked.**

EPO port (Optional)

A customer-supplied switch can remotely use to open the EPO connection and shut off UPS output. Since EPO shuts down the UPS immediately without regular procedure and monitoring, UPS will require a manual restart to restore operation.

3.3 Connection to External Battery Pack

- External battery connections shall install by service personnel **only**.
- Please read safety instructions first before proceeding.
- Ensure UPS disconnects from all main and loads before attempting.
- Locate the battery connector, then use **only** factory-supplied or authorized battery cable provided to connect the UPS with the battery as fig below
- Connect the second battery to the first one if more than one is needed
- The Maximum quantity of battery pack is regulated to 2 by UL approval.

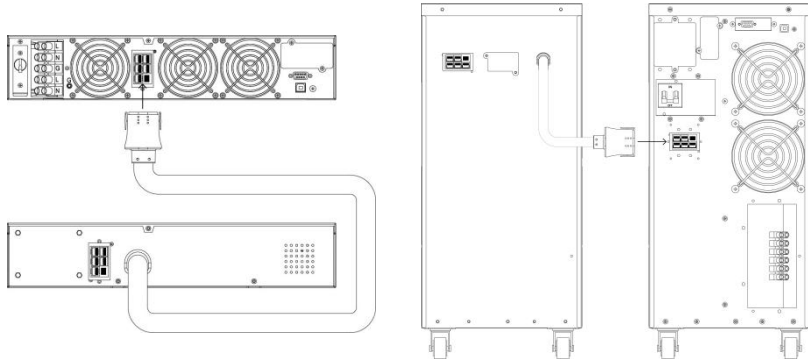

● Fig. Example of connecting to an external battery pack

3.4 Connection to Main and Load

- Follow all installation and safety instructions very carefully; failure to do so may cause hazardous situations to personnel and equipment.
- Ensure the main power voltage matches with UPS. (220V)
- For electrical installation, closely observe the nominal current rating of the source.
- Check the equipment's power requirement to prevent overloading situations.
- Do not connect devices that draw either massive power shortly or half-wave rectified current - such as hairdryer, vacuum cleaner, laser printer, and plotter.

Note: Although you may use the UPS immediately, maximum back up time will not be available yet. It is recommended to charge the batteries for a minimum of 8 hours before use

- Only a qualified technician with applicable safety standers may carry out the installation. Installation must also comply with local legislation and regulations.
- Connect input to the UPS and the other end to a grounded outlet. The battery will automatically charge when connecting to the main power.
- Ensure the installation site has all electrical connections needed. Refer to the figure below for the fuse & cable dimension and connection diagram.
- To Isolate and secure the source against reclosing, both input and output circuit breakers (located in the back) must be "OFF."
- After charging the UPS, connect the loads to the UPS
- Should computer or alarm connections be used, refer to UPS monitoring connection chapter for further detail
- **Note:** During installation, if whether the main power is grounded cannot be determined, or the main power's neutral is unreliable, an additional two-pole disconnect device is necessary for building installation.
- **Caution:** Local safety requirements may demand separate external Emergency Power Off. Refer to External breaker/ EPO connection for further detail
- The installation is completed.

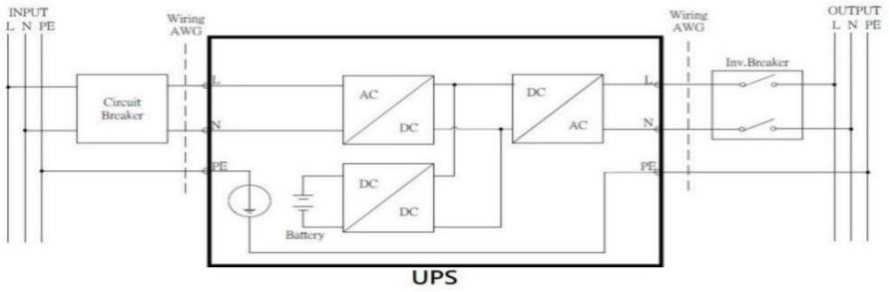

Note: Wiring cord must be UL approved. (105°C)

Model	Circuit Breaker	Wiring AWG or mm ²
6000VA	50A/240Vac	8 AWG or 8 mm ²
10000VA	70A/240Vac	6 AWG or 14 mm ²

External Breaker/External EPO connection

Due to certain local safety requirements and legislation, you may require a separate external Emergency Power Off for output circuit breaker. If you need an external breaker for safety or maintenance reason, use the fig below for installation.

External Maintenance Breaker Wiring connection.

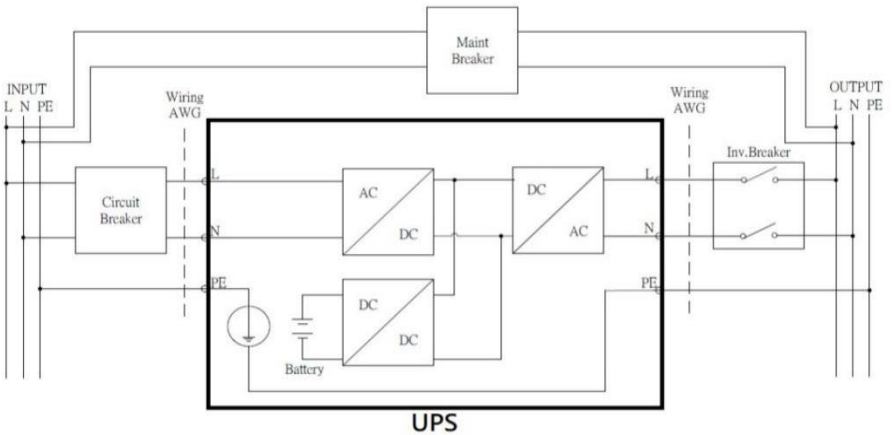

4. Operation

Necessary information for the operation of the unit is covered in this chapter. Normally UPS runs automatically, but on a few occasions such as just after installation, all procedures are described herein.

4.1 General Description

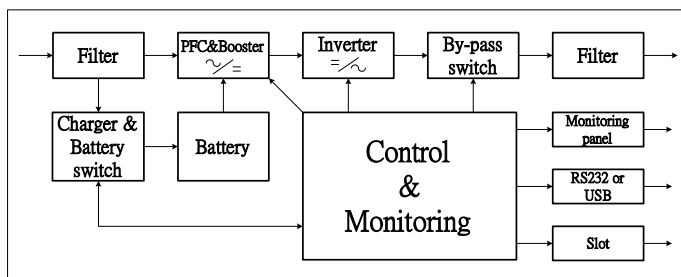

As double conversion On-line UPS, it can convert clean single-phase power to support your critical system. The diagram of UPS is as shown above.

- Input filter reduces transients and interference from the main
- With PFC AC/DC, AC-power is rectified and regulated to DC power
- DC power is converted to AC in the inverter passing it on to the load

Line-Mode/Battery-Mode

UPS will operate in Line-Mode that supports power and charge battery while connected to power. During a power failure, the UPS will switch to Battery-Mode, in which power is maintained from the battery. In case of failure time exceed Battery-Mode duration, UPS will shut down until voltage return to prevent battery discharge.

Free Run Mode

Free Run Mode provides a wider input frequency range when input frequency does not match the selected range (user adjustable). Free Run Mode enlarges input frequency acceptance up to 45Hz ~ 65Hz but fixes output frequency to 50Hz and 60Hz with ± 0.25 Hz. Free Run Mode designs for large power variation. It is activated in default and can run with Line-mode simultaneously.

High-Efficiency Mode

High-Efficiency Mode designs to minimize power loss and power consumption. Whenever power is stable, UPS will automatically switch to bypass for efficiency. When any irregularity is detected, Line-Mode will reactivate immediately. Switching occurs when the input voltage is outside $\pm 10\%$ of nominal ($\pm 15\%$ selectable), input frequency is outside of ± 3 Hz, or when no input line is available.

You can also activate this mode from the LCD panel. Refer to UPS configuration.

Diagnostic Test

The diagnostic test automatically executes to check and report UPS status. While the advanced battery management system monitors the conditions of the batteries, it sends early warnings if a battery replacement is needed. The test performs every 30 days of normal mode operation. Diagnostic tests can also be performed by manual control.

Generator mode

This mode designs for highly unstable power. In this mode, UPS normal operation will not transfer to bypass to prevent load damage and frequent battery discharge. UPS will also fix output frequency to 50Hz(220V) or 60Hz(220V) with ± 0.25 Hz. Users can set the UPS to bypass/shutdown whenever UPS malfunction occurred.

Generator Mode can activate from the LCD panel too.

4.2 System Configuration

The UPS device and battery make up the system. Depending on site and load requirements, certain additional options are available as tailored solutions. Please consider the following when planning your UPS system:

- The total demand for the protected system shall dictate the output power rating (VA). When measuring demand, please allow a margin for future expansion and calculation error.
- Battery-mode duration needs dictate the battery size. If the load is less than the UPS nominal power rating, then the actual backup time is longer.
- The following options are available:
 - Connectivity options (relay card, SNMP/WEB card)
 - External battery packs
 - Transformer cabinets
 - Maintenance bypass switches

4.3 Panel overview

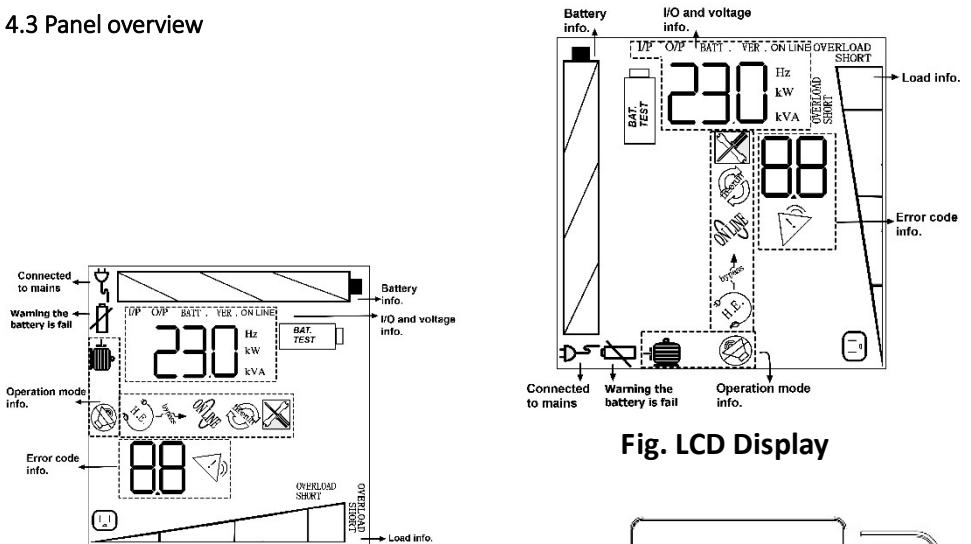
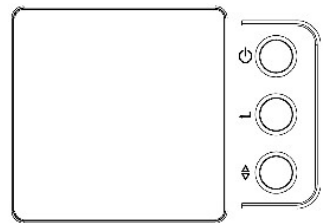



















Fig. LCD Display



Control Panel

4.4 UPS Control

Control panel functions

Display	Function Description	Display	Function Description
LCD Display			
	<u>Connected to Mains.</u> UPS connects with input Power		<u>Line Mode</u> System operating normally with Main power
	<u>Battery Power Indication</u> 0-24/25-49/50-74/75-100% remaining		<u>Free-run Mode</u> UPS operating in Free Run Mode
	<u>Battery Test</u> UPS is conducting a battery test		<u>Manual Bypass</u> UPS is on manual bypass mode (maintenance only)
	<u>Battery Failure</u> Battery failed Check your battery		<u>Fault</u> UPS Internal/external fault. Error code will display beside it.
	<u>Generator Mode</u> UPS is operating on Generator mode	OVERLOAD	<u>Overloading</u> UPS suffers an overload problem. Output exceeds UPS capacity
	<u>Silence Mode</u> UPS silence mode Enabled	SHORT	<u>Output Short Circuit</u>
	<u>High-Efficiency Mode</u> UPS operating on high-efficiency mode		<u>Output Working Normally</u> UPS supporting surge protective power to connected equipment
	<u>Bypass Mode</u> UPS operating on Bypass mode		<u>UPS Load Level</u> UPS on 0-24/25-49/50-74/75-100% Load level
Button Display			
	<u>ON/OFF</u> To turn on and off UPS, refer to Button Operation		<u>Status/Enter</u> To check UPS status and confirm settings, refer to Button Operation
	<u>Setting / Selection</u> To select and check UPS settings refer to Button Operation		



Button operation

Cold Start function

When the main power is disconnected from UPS, it is capable of starting with battery power for users' needs. Simply start the UPS as the instruction below.

Note: To avoid accidental battery discharge, cold start function is not available until the initial connection to the main power.

1. "ON/OFF" button

- (a) Press and hold the "
- (b) Press and hold the "

2. "Status/Enter" button ↵

Use this button to check the content and confirm the selection of UPS.

- Press and hold "↵" button for 1 second to check UPS contents.
- Display each status by pressing once. There are **10** statuses available for users.
- Enter** function only uses during settings. Check the "◀" button for more detail.
- If UPS idles for 20 seconds, the display will return to the main status.

3. "Settings or Selection" button ◀

Use this button and "ENTER" button to execute the setting

- Press and hold the "◀" button for 1 second to enter the configurations of UPS.
- Display each setting by pressing the "◀" once. There are 7 settings available for users.
- Press the "↵" button to enter the function.
- Press the "◀" button to select your option.
- Press the "↵" button to confirmation (YES/NO) of your selected option.
- Press the "↵" button again to confirm and enable your function.
- If UPS is idle over 10 seconds, the display will return to the main status.

Turn on the UPS

- Ensure installation is correct and successful, and connect the input power cable to a well-grounded outlet.
- Push the "on/off" bottom on the front panel for 3 seconds.
- UPS should start its inspection of internal function, main synchronization, and inverter start-up. The LCD panel will display "Line-Mode" indication and power should start supplying via the outlets
- Switch on the loads

Shut Down the UPS

- Shut down and turn off all the loads
- Press the "On/Off" for 3 seconds. UPS will shut down with an alarm
- (If applicable) To avoid electrical hazards, please turn off the internal/external input breaker after the display disappeared, and only the backlight remains. Then, turn off any external battery breaker and wait till all fans completely shut down.
- In an emergency, use the EPO located on the rear panel.

4.5 UPS Status Display

UPS status shows in normal display mode. From here, you can go to the UPS meter display by pressing the button. Various measurements are available through UPS meters display; Pressing the button will scroll through the following meters.'

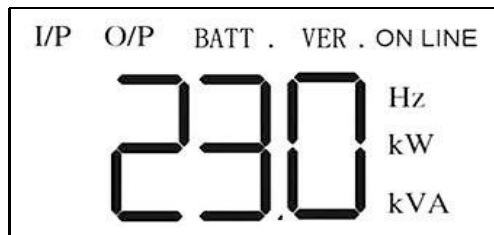



LCD message	Description
O/P x x x V	Shows Output AC Voltage
O/P x x.x Hz	Shows Output Frequency
I/P x x x V	Shows Input AC Voltage
I/P x x.x Hz	Shows Input Frequency
BATT. x x.x V	Shows Battery Voltage
O/P x x x W	Shows Output Capacity (Watts)
O/P x x x VA	Shows Output Capacity (VA)
O/P x x A	Shows Output Current
VER. x kVA	Shows UPS Rating
VER. x.x.x	Shows UPS Firmware Version

4.6 UPS Configuration

Caution: Factory default settings do not necessarily have to be changed, although you are free to tailor the UPS as your specific needs.

Here are the procedures to enter configuration mode

Press and hold the “” button for 1 second to enter the configuration mode

Display each setting by pressing the “” once. There are 7 settings available for user









Press the “” button to enter the function.

Press the “” button to select your options.

Press the “” button to confirmation (YES/NO) of your selected option.

Press the “” button again to confirm and enable your function.

If UPS is idle over 10 seconds, the display will return to the main menu.

Function Setting	Icon	Available Setting	Default Setting
Setting		--	--
Output Voltage		[208V][220V][230V][240V]	[220V]
Perform Battery Test		[On][Off]	[Off]
Manual Bypass		[On][Off]	[Off]
Free Run Mode		[On][Off]	[On]
High-Efficiency Mode		[On][Off]	[Off]
Silence		[On][Off]	[Off]
Generator Mode		[On][Off]	[Off]

UPS Manual test

Manual tests for UPS or battery can be conducted from the UPS configuration as well and are functional even when the UPS is not charging the battery.

Simple test: It's recommended to conduct a simple simulation test when

1. The first use of UPS.
2. Adding new loads.
3. 6 months' regular check-up

Switch on the UPS and wait for the power indicator to light up, then unplug UPS to simulate the main power failure.

Manual Battery Test: Scroll through configuration until the Manual Battery test function displayed. Then select by pressing "**Enter**" Twice

5. UPS Monitoring Connection

UPSMON Pro software (Or other power monitoring software) can further utilize the UPS with warning reminders, monitoring, control shut down, and setting adjustments.

Using monitoring features requires connecting the UPS to a computer or the internet

5.1 Connect UPS to Computer with USB /RS232 port.

- Locate the USB/RS232 port on UPS.
- Connect with factory-provided/approved communication cable
- Ensure your computer can install and support power management software.
- **Note:** Either USB Port or RS232 port, only one port will function at a time.

5.2 Connect UPS with interface Slot(Optional)

- **SNMP Card** allows UPS management and monitoring over a network or internet
- For more information, please contact for technical assistance.
- **AS400 Card** allows voltage free relay contacts

5.3 UPS RS232 PORT

- The RS-232 interface uses a 9-pin female D-sub connector.
- The RS-232 port carries the data about utility, load, and UPS.
The interface port pins and their functions are in the following table



Pin #	Signal	Direction	Function
2	TxD	Output	TxD Output
3	RxD	Input	RxD / Inverter Off Input
5	Common		Common
6		Output	AC Fail Output
8		Output	Low Battery Output
9		Output	12VDC Power

Caution! Max rated values 12VDC

6. Maintenance

Please read the following instruction to ensure your safety and maintain a longer product lifetime. This section contains detailed information about moving, maintaining, and placing the UPS. With a minimal amount of maintenance, you can expect the UPS to function smoothly.

6.1 Transportation

Please handle UPS with extreme caution since a high amount of energy is within the batteries. Keep the unit in position as marked on the packaging and never drop the unit.

6.2 Storage

Please read the following instructions if the UPS is not installed immediately:

- Store the equipment as is in its original packing and shipping carton.
- Do not store in temperatures outside the range of +15°C to +25°C.
- Protect the equipment from wet or damp areas and moist air.
- To maintain the vitality of the batteries, please recharges the UPS at least 8 hours every six months.

6.3 Operation

CAUTION: Ensure that all environmental concerns and requirements are met according to safety instruction; otherwise, the safety of installation personnel cannot be guaranteed since the unit may malfunction.

- Please ensure no flammable substances such as gases or fumes.
- Avoid extreme temperature and humidity. Protect the equipment from moisture.
- Ensure there is enough space (300mm or above recommended) at the rear and side of UPS for proper ventilation.
- Ensure that the front of the UPS remains clear for user operation.
- **Only** authorized agents or technicians may service the unit.
- **Do not** open the UPS cabinet. Components may contain hazardous or fatal voltage.
- Output receptacles may carry live voltage without connecting to the main power.
- Pay special attention to UPS air inlet; **do not** let it covered by dust.

6.4 Battery

6.4.1 Maintenance

The reliability of the battery is heavily related to the environmental issue.

At the temperature of 25 degrees Celsius, A regular 6-12 months' checkup is advised.

6.4.2 Replacement

Caution: Read safety instruction before proceeding.

In all the following steps and factory stander:

The **black** battery cable is the **negative (-)** pole

The **red** battery cable is **positive (+)** pole

Caution: Avoid battery positive port directly contacts with metal. (including UPS cover)

Caution: Do not remove the battery during battery-mode.

1. Ensure UPS is turned Off and disconnected from main and load
2. Disconnect the external battery cabinet/ battery packs.
3. Replace with the same type and unit of batteries.
4. See Connection to External Battery Pack for installation.

Note: Rack model does not contain an internal battery

Note: Tower model battery replacements are not available by users. Please contact for technical assistance

6.4.3 External battery pack









The following chart is the recommended specification of the external battery pack/cabinet. For other options, please ensure that the option meets safety instruction and local legislation.

Note: when power supplies by external batteries, output loads will be limited to 90% for overall power generation.







Model		6000	10000
Battery type		Lead-acid 5 AH / 12V 2U	Lead-acid 9 AH / 12V_3U
Number of batteries		20	
Full/Half load Back-up time (Battery Only)	1 Set battery	Approx. 2-4 / 9-11 (Min)	Approx. 1.5-2.5min/ 7-9(Min)
	2 set battery	Approx. 9-11/ 27-29 (Min)	Approx. 7-9 min/18-20(Min)
Recharge time		1 Set - 6 hour to 90% / 2 Set_12 hour to 90%	
Dimensions W x D x H mm	RM2U	428x635x84	--
Net Weight Kg	RM2U	42	--
Dimensions W x D x H mm	RM3U	428x597x130	428x657x130
Net Weight Kg	RM3U	66	68

Maintenance Bypass Procedure

1. Maintenance

- (1) Press  ON/OFF button to turn UPS on and UPS goes to  "Line mode".
- (2) Press  Function button (at least 2 seconds) to choose  Manual Bypass figure and Press  "Enter" button to select it . After that you will see Bypass "OFF" Picture in LCD .
- (3) Toggle the  Function button again, see Bypass "YES" and press  Enter button It will make UPS goes to 'Manual Bypass mode' 

2. Restore

- (1) Press  Function button (at least 2 seconds) to choose  Manual Bypass figure and Press  "Enter" button to select it . After that you will see Bypass "YES" Picture in LCD .
- (2) Toggle the  Function button again, see Bypass " OFF" and press  Enter button It will make UPS goes to  'Line mode'

APP-A. Troubleshooting

Troubleshooting procedures give simple instructions in determining UPS malfunctions. Start the troubleshooting procedure if you witness any alarm indication.

Alarm

The UPS has an audible alarm. When different situations occurred, UPS will alert users with display and buzzer.

Please refer to the troubleshooting chart below for detail information

Silencing Alarm

Here is the instruction to mute the active alarm or future alarm notification:

Note: During battery-mode, if the battery is low on power, the alarm will sound regardless of silent-mode enable/disable.

Silencing during Battery-Mode: Press any button when the alarm occurred.

Silent Mode: configure on LCD to enable/disable all audio malfunction warning.

If troubleshooting does not include or resolve your situation, feel free to contact for technical assistance.

Situation	Alarm & Display	Description & Solution
1. High Output Voltage	Constant beep	High output voltage. Please contact for technical assistance
2. Low output Voltage	Constant beep	Low output voltage. Please Contact for technical assistance
3. Output short	Constant beep	Output short circuit. Please contact for technical assistance
4. Bus fault	2 beep/seconds	High internal DC bus Voltage. Please contact for technical assistance
5. Over-temperature	2 beep/seconds	High surrounding temperature. Ensure fan operational and ventilation clear. Contact for technical assistance If the problem remains
6. Set wiring fault	1 beep/seconds	Wrong UPS input wiring between natural and line, turn the plug 180 degrees and plug it in.
7. Output overload	2 beep/seconds	Connected equipment power requirements exceed UPS provision. UPS will switch to bypass mode when overload in Line-mode. Shut off less essential equipment connected to UPS. UPS automatically switches back to normal when the problem resolves.
8. Over-charge	Constant beep	Battery overcharged, Turn off UPS and contact for technical assistance
9. Charger failure	N/A	The charger has failed. Contact for technical assistance
10. Battery failure	3 beep/5 econds	The battery has failed. Contact for technical assistance
11. Line abnormal	1beep/seconds	Wrong AC line backed up during auto restart. Please reconfirm your main power and frequency
12. Battery test	N/A	UPS battery test processing. UPS will return to or mal operation after completion. No action needed
13. Battery mode	1 beep/5 seconds with display	Unit is operating with battery power, secure your data and perform a controlled shutdown
14. Low battery	2 beep/5 seconds with display	UPS will shut down due to low battery voltage. The unit will restart automatically when sufficient power returns.
15.*Bypass mode	N/A	When the bypass mode is displayed *Please turn off the UPS before removing the input power, and contact for technical assistance

Note: when Bypass Mode activated, the Alarm will not sound regardless of the situation.

APP-B Technical Specifications

For all model:

* While 200V output, capacity will be derated to 80%.

* While 208V output, capacity will be derated to 90%.

** Specifications are subject to change without further notice.

** Specifications are for reference; actual information should be based on the real product.

Rack Model	6000	10K	
Configuration			
Capacity (VA / Watts)	6000 VA / 6000 W	10 KVA / 10 KW	
Form	Rack and Tower Type		
Phase	Single Phase		
Energy Saving	Yes - ECO Mode Efficiency >94%		
Input			
Voltage	208 / 220 / 230 / 240 Vac		
Input Voltage Range	120 - 276 VAC, < 25% Load / 140 - 276 VAC, < 50% Load 160 - 276 VAC, < 75% Load / 180 - 276 VAC, < 100% Load		
Input Frequency Range	50 / 60 Hz (Auto Sensing)		
Input Power Factor	>0.97		
Cold Start	Yes		
Output			
Rated Power Factor	1.0		
Waveform	Pure Sine Wave		
Voltage	200* / 208* / 220 / 230 / 240 Vac \pm 2%		
Frequency	50 / 60 Hz \pm 0.25 Hz		
Transfer Time	0 ms		
Harmonic Distortion	\leq 3% THD at Linear Load		
Crest Factor	3 : 1		
EPO Function	Option		
Protection			
Overload	Line Mode	105% - 120% for 30 seconds / 121% - 150% for 10 seconds	
	Battery Mode	101% - 109% for 10 seconds / 110% - 120% for 3 seconds	
Surge Protection	IEC 61000-4-5 Level 3		
Bypass	Internal Bypass (Automatic and Manual)		
Short Circuit Protection	UPS Output Cut Off Immediately		
Battery			
Type	12V 7Ah	12V 9Ah	
Internal Batt.	External Batt.	External Batt.	
Quantity	20	20	
Sealed, Maintenance Free	Yes		
Typical Recharge Time	4 hr to 90%		
External Battery Module	Option		
External Battery Connector	Option		
Management & Communication			
LCD Control Panel	Yes		
Communication Port	RS 232, USB B type		
SNMP Slot	Option		
Audible Alarms	Yes		
Physical			
Power Module	Dimensions (WxDxH) (mm)	428 x 635 x 84	
	Weight (kgs)	15.8	20
	Shipping Dimensions (mm)	550 x 750 x 220	
	Shipping Weight (kgs)	19.6	24
Batt. Module	Dimensions (WxDxH) (mm)	428 x 635 x 84 (2U)	428 x 657 x 130 (3U)
	Weight (kgs)	42	68
	Shipping Dimensions (mm)	550 x 750 x 220	590 x 830 x 370
	Shipping Weight (kgs)	45.6	83

Tower Model		6000	10K
Configuration			
Capacity (VA / Watts)		6000 VA / 6000 W	10 KVA / 10 KW
Form		Tower Type	
Phase		Single Phase	
Energy Saving		Yes - ECO Mode Efficiency >94%	
Input			
Voltage		208 / 220 / 230 / 240 Vac	
Input Voltage Range		120 - 276 VAC, < 25% Load / 140 - 276 VAC, < 50% Load 160 - 276 VAC, < 75% Load / 180 - 276 VAC, < 100% Load	
Input Frequency Range		50 / 60 Hz (Auto Sensing)	
Input Power Factor		>0.97	
Cold Start		Yes	
Output			
Rated Power Factor		1.0	
Waveform		Pure Sine Wave	
Voltage		200* / 208* / 220 / 230 / 240 Vac ± 2%	
Frequency		50 / 60 Hz ±0.25 Hz	
Transfer Time		0 ms	
Harmonic Distortion		≤ 2.5% THD at Linear Load	
Crest Factor		3 : 1	
EPO Function		Option	
Protection			
Overload	Line Mode	105% - 120% for 30 seconds 121% - 150% for 10 seconds	
	Battery Mode	101% - 109% for 10 seconds 110% - 120% for 3 seconds	
Surge Protection		IEC 61000-4-5 Level 3	
Bypass		Internal Bypass (Automatic and Manual)	
Short Circuit Protection		UPS Output Cut Off Immediately	
Battery			
Type		12V 7Ah	12V 9Ah
Quantity		20	20
Sealed, Maintenance Free		Yes	
Typical Recharge Time		4 hr to 90%	
External Battery Module		Option	
External Battery Connector		Option	
Management & Communication			
Indicator		LCD Control Panel	
Communication Port		RS 232, USB B type	
SNMP Slot		Option	
Audible Alarms		Yes	
Physical			
Dimensions (WxDxH) (mm)		257 x 590 x 570	
Weight (kgs)		78	88.4
Shipping Dimensions (mm)		380 x 710 x 735	
Shipping Weight (kgs)		87	97.4

20210907